

# C3M0045065D

## Silicon Carbide Power MOSFET

### C3M™ MOSFET Technology

#### N-Channel Enhancement Mode

#### Features

- 3<sup>rd</sup> Generation SiC MOSFET technology
- High blocking voltage with low on-resistance
- High speed switching with low capacitances
- Fast intrinsic diode with low reverse recovery (Qrr)
- Halogen free, RoHS compliant

#### Benefits

- Higher system efficiency
- Reduced cooling requirements
- Increased power density
- Increased system switching frequency
- Easy to parallel and simple to drive
- Enable new hard switching PFC topologies (Totem-Pole)

#### Applications

- EV chargers
- Server & Telecom PSU
- UPS
- Solar inverters
- SMPS
- DC/DC converters

$V_{DS}$	650 V
$I_D @ 25^\circ\text{C}$	49 A
$R_{DS(on)}$	45 mΩ

#### Package

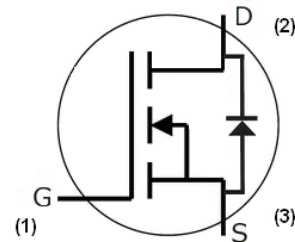
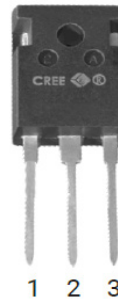

Part Number	Package	Marking
C3M0045065D	TO-247-3	C3M0045065D

#### Maximum Ratings

Symbol	Parameter	Value	Unit	Note
$V_{DSS}$	Drain - Source Voltage, $T_C = 25^\circ\text{C}$	650	V	
$V_{GS}$	Gate - Source voltage (Under transient events < 100 ns)	-8/+19	V	Fig. 29
$I_D$	Continuous Drain Current, $V_{GS} = 15\text{ V}$ , $T_C = 25^\circ\text{C}$	49	A	Fig. 19
	Continuous Drain Current, $V_{GS} = 15\text{ V}$ , $T_C = 100^\circ\text{C}$	35		
$I_{D(pulse)}$	Pulsed Drain Current, Pulse width $t_p$ limited by $T_{Jmax}$	132	A	
$P_D$	Power Dissipation, $T_C=25^\circ\text{C}$ , $T_J = 175^\circ\text{C}$	176	W	Fig. 20
$T_J, T_{stg}$	Operating Junction and Storage Temperature	-40 to +175	$^\circ\text{C}$	
$T_L$	Solder Temperature, 1.6mm (0.063") from case for 10s	260	$^\circ\text{C}$	
$M_d$	Mounting Torque, (M3 or 6-32 screw)	1	Nm	
		8.8		

Symbol	Parameter	Min.	Typ.	Max.	Unit	Test Conditions	Note	
$V_{(BR)DSS}$	Drain-Source Breakdown Voltage	650			V	$V_{GS} = 0\text{ V}, I_D = 100\ \mu\text{A}$		
$V_{GSon}$	Gate-Source Recommended Turn-On Voltage		15		V	Static	Fig. 29	
$V_{GSoff}$	Gate-Source Recommended Turn-Off Voltage		-4		V			
$V_{GS(th)}$	Gate Threshold Voltage	1.8	2.6	3.6	V	$V_{DS} = V_{GS}, I_D = 4.84\ \text{mA}$	Fig. 11	
			2.2		V	$V_{DS} = V_{GS}, I_D = 4.84\ \text{mA}, T_J = 175^\circ\text{C}$		
$I_{DSS}$	Zero Gate Voltage Drain Current		1	50	$\mu\text{A}$	$V_{DS} = 650\ \text{V}, V_{GS} = 0\ \text{V}$		
$I_{GSS}$	Gate-Source Leakage Current		10	250	nA	$V_{GS} = 15\ \text{V}, V_{DS} = 0\ \text{V}$		
$R_{DS(on)}$	Drain-Source On-State Resistance		45	60	m $\Omega$	$V_{GS} = 15\ \text{V}, I_D = 17.6\ \text{A}$	Fig. 4, 5, 6	
			60			$V_{GS} = 15\ \text{V}, I_D = 17.6\ \text{A}, T_J = 175^\circ\text{C}$		
$g_{fs}$	Transconductance		12		S	$V_{DS} = 20\ \text{V}, I_{DS} = 17.6\ \text{A}$	Fig. 7	
			11			$V_{DS} = 20\ \text{V}, I_{DS} = 17.6\ \text{A}, T_J = 175^\circ\text{C}$		
$C_{iss}$	Input Capacitance		1621		pF	$V_{GS} = 0\ \text{V}, V_{DS} = 0\ \text{V to } 600\ \text{V}$ $F = 1\ \text{Mhz}$ $V_{AC} = 25\ \text{mV}$	Fig. 17, 18	
$C_{oss}$	Output Capacitance		101					
$C_{rss}$	Reverse Transfer Capacitance		8					
$C_{o(er)}$	Effective Output Capacitance (Energy Related)		126					Note: 1
$C_{o(tr)}$	Effective Output Capacitance (Time Related)		178					Note: 1
$E_{oss}$	$C_{oss}$ Stored Energy		20		$\mu\text{J}$	$V_{DS} = 600\ \text{V}, F = 1\ \text{Mhz}$	Fig. 16	
$E_{ON}$	Turn-On Switching Energy (Body Diode)		210		$\mu\text{J}$	$V_{DS} = 400\ \text{V}, V_{GS} = -4\ \text{V}/15\ \text{V}, I_D = 17.6\ \text{A},$ $R_{G(ext)} = 2.5\ \Omega, L = 99\ \mu\text{H}, T_J = 175^\circ\text{C}$ FWD = Internal Body Diode of MOSFET	Fig. 25	
$E_{OFF}$	Turn Off Switching Energy (Body Diode)		42					
$E_{ON}$	Turn-On Switching Energy (External Diode)		161		$\mu\text{J}$	$V_{DS} = 400\ \text{V}, V_{GS} = -4\ \text{V}/15\ \text{V}, I_D = 17.6\ \text{A},$ $R_{G(ext)} = 2.5\ \Omega, L = 99\ \mu\text{H}, T_J = 175^\circ\text{C}$ FWD = External SiC DIODE	Fig. 25	
$E_{OFF}$	Turn Off Switching Energy (External Diode)		42					
$t_{d(on)}$	Turn-On Delay Time		10		ns	$V_{DD} = 400\ \text{V}, V_{GS} = -4\ \text{V}/15\ \text{V}$ $I_D = 17.6\ \text{A}, R_{G(ext)} = 2.5\ \Omega, L = 99\ \mu\text{H}$ Timing relative to $V_{DS}$ Inductive load	Fig. 26	
$t_r$	Rise Time		32					
$t_{d(off)}$	Turn-Off Delay Time		20					
$t_f$	Fall Time		8					
$R_{G(int)}$	Internal Gate Resistance		3		$\Omega$	$f = 1\ \text{MHz}, V_{AC} = 25\ \text{mV}$		
$Q_{gs}$	Gate to Source Charge		20		nC	$V_{DS} = 400\ \text{V}, V_{GS} = -4\ \text{V}/15\ \text{V}$ $I_D = 17.6\ \text{A}$ Per IEC60747-8-4 pg 21	Fig. 12	
$Q_{gd}$	Gate to Drain Charge		20					
$Q_g$	Total Gate Charge		63					

Note (1):  $C_{o(er)}$ , a lumped capacitance that gives same stored energy as  $C_{oss}$  while  $V_{ds}$  is rising from 0 to 400V  
 $C_{o(tr)}$ , a lumped capacitance that gives same charging time as  $C_{oss}$  while  $V_{ds}$  is rising from 0 to 400V

### Reverse Diode Characteristics ( $T_C = 25^\circ\text{C}$ unless otherwise specified)

Symbol	Parameter	Typ.	Max.	Unit	Test Conditions	Note
$V_{SD}$	Diode Forward Voltage	4.8		V	$V_{GS} = -4\text{ V}, I_{SD} = 8.8\text{ A}, T_J = 25^\circ\text{C}$	Fig. 8, 9, 10
		4.2		V	$V_{GS} = -4\text{ V}, I_{SD} = 8.8\text{ A}, T_J = 175^\circ\text{C}$	
$I_S$	Continuous Diode Forward Current		29	A	$V_{GS} = -4\text{ V}, T_C = 25^\circ\text{C}$	
$I_{S, pulse}$	Diode pulse Current		132	A	$V_{GS} = -4\text{ V}$ , pulse width $t_p$ limited by $T_{Jmax}$	
$t_{rr}$	Reverse Recover time	26		ns	$V_{GS} = -4\text{ V}, I_{SD} = 17.6\text{ A}, V_R = 400\text{ V}$ $dif/dt = 1220\text{ A}/\mu\text{s}, T_J = 175^\circ\text{C}$	
$Q_{rr}$	Reverse Recovery Charge	171		nC		
$I_{rrm}$	Peak Reverse Recovery Current	11		A		
$t_{rr}$	Reverse Recover time	34		ns	$V_{GS} = -4\text{ V}, I_{SD} = 17.6\text{ A}, V_R = 400\text{ V}$ $dif/dt = 850\text{ A}/\mu\text{s}, T_J = 175^\circ\text{C}$	
$Q_{rr}$	Reverse Recovery Charge	156		nC		
$I_{rrm}$	Peak Reverse Recovery Current	8		A		

### Thermal Characteristics

Symbol	Parameter	Typ.	Unit	Test Conditions	Note
$R_{\theta JC}$	Thermal Resistance from Junction to Case	0.85	$^\circ\text{C}/\text{W}$		Fig. 21
$R_{\theta JA}$	Thermal Resistance From Junction to Ambient	40			

## Typical Performance

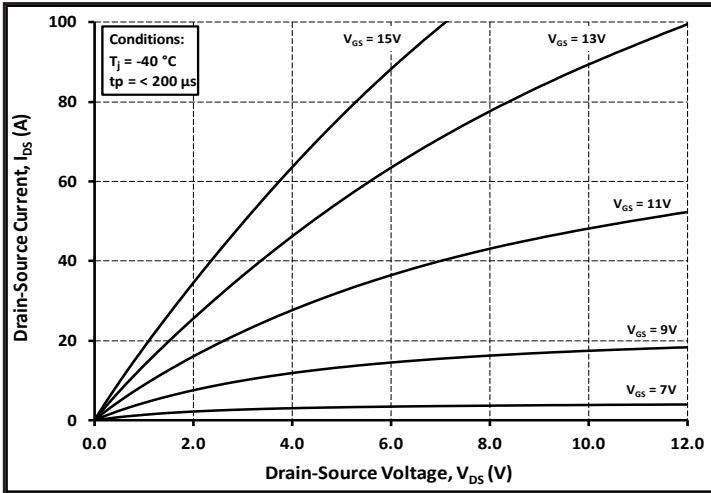

Figure 1. Output Characteristics  $T_J = -40\text{ }^\circ\text{C}$

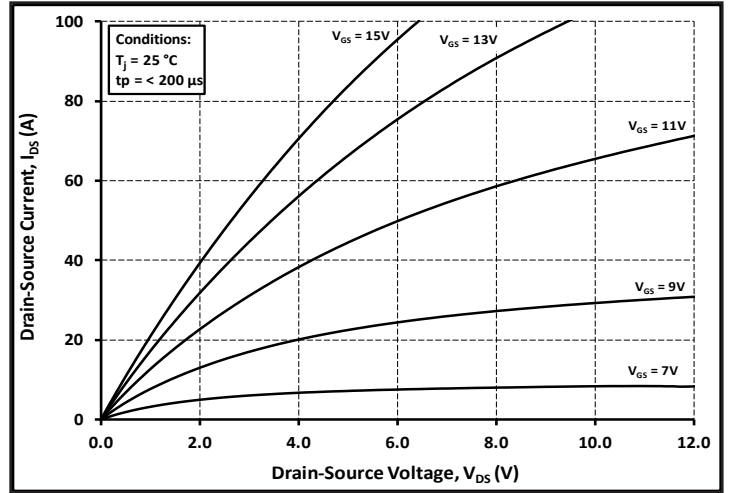

Figure 2. Output Characteristics  $T_J = 25\text{ }^\circ\text{C}$

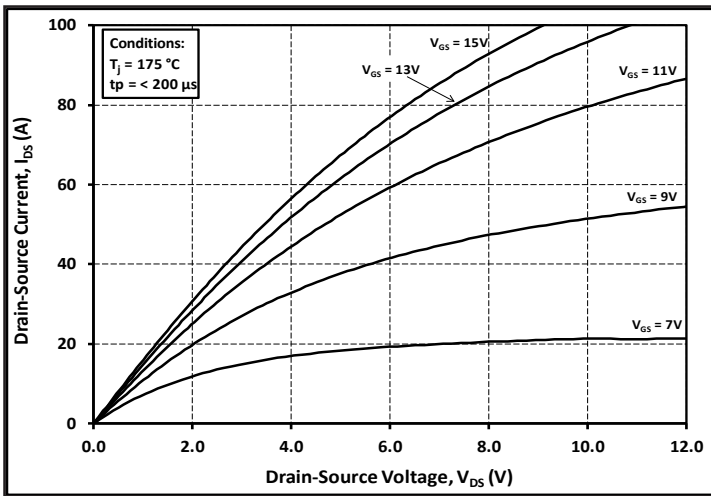

Figure 3. Output Characteristics  $T_J = 175\text{ }^\circ\text{C}$

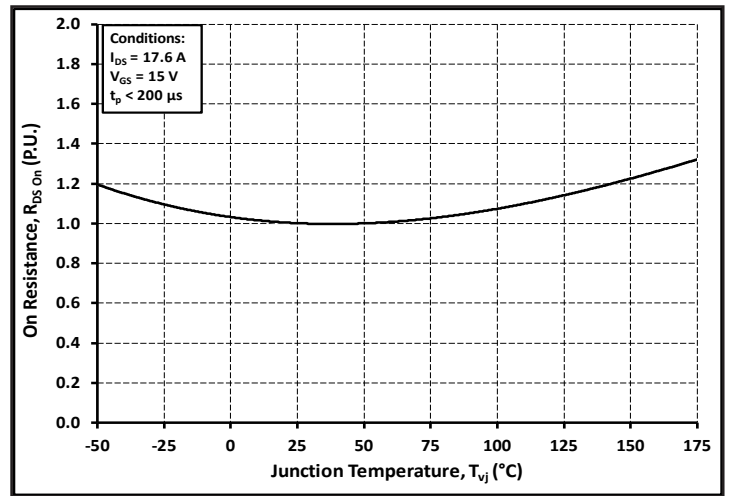

Figure 4. Normalized On-Resistance vs. Temperature

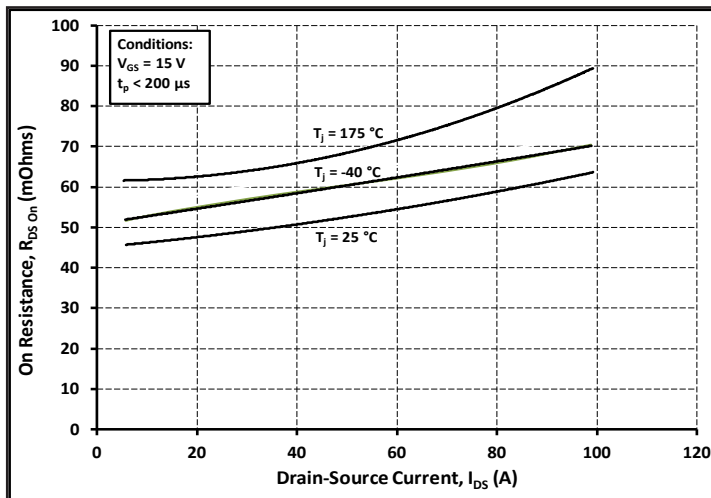

Figure 5. On-Resistance vs. Drain Current For Various Temperatures

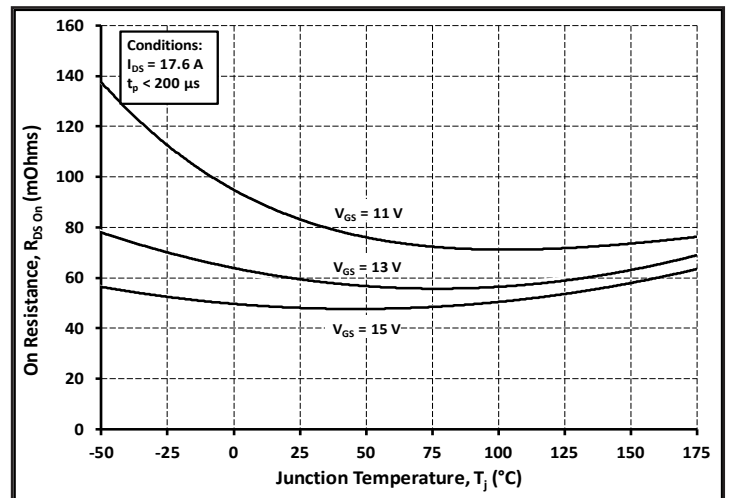

Figure 6. On-Resistance vs. Temperature For Various Gate Voltage

## Typical Performance

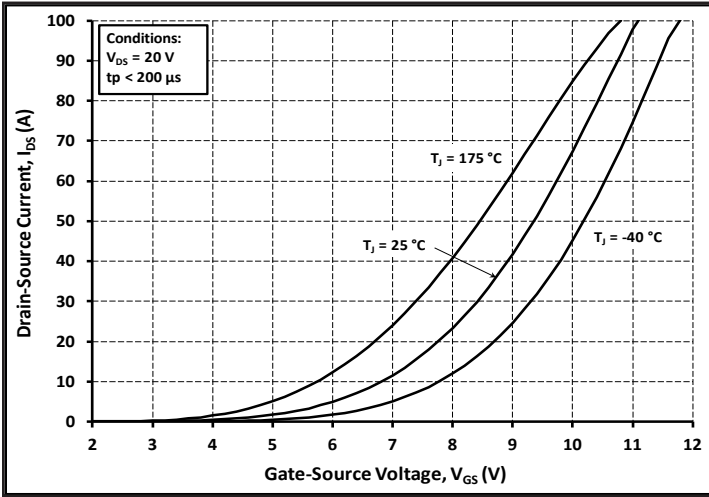

Figure 7. Transfer Characteristic for Various Junction Temperatures

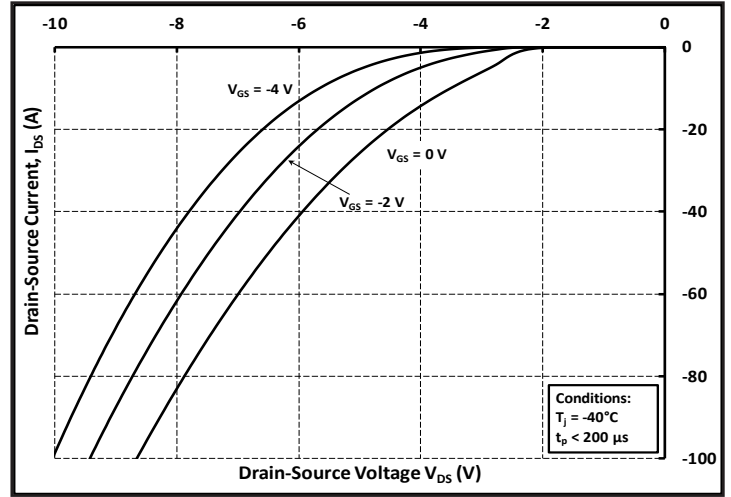

Figure 8. Body Diode Characteristic at -40 °C

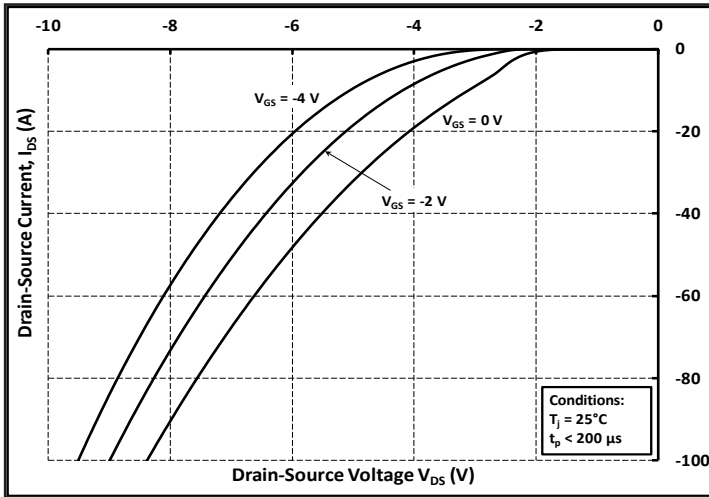

Figure 9. Body Diode Characteristic at 25 °C

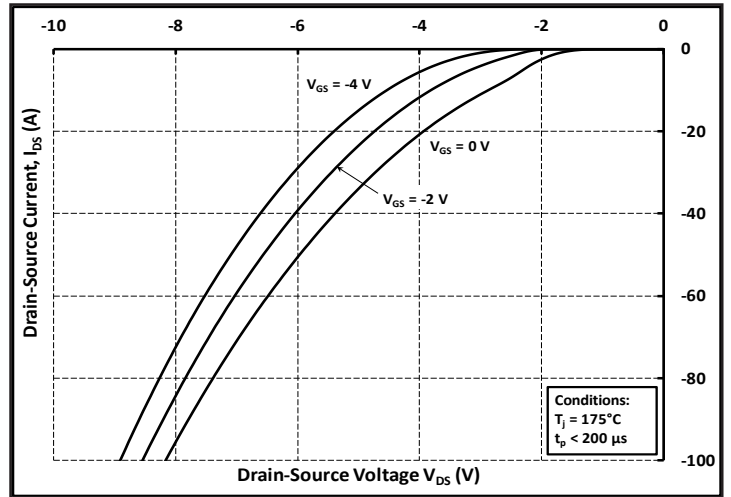

Figure 10. Body Diode Characteristic at 175 °C

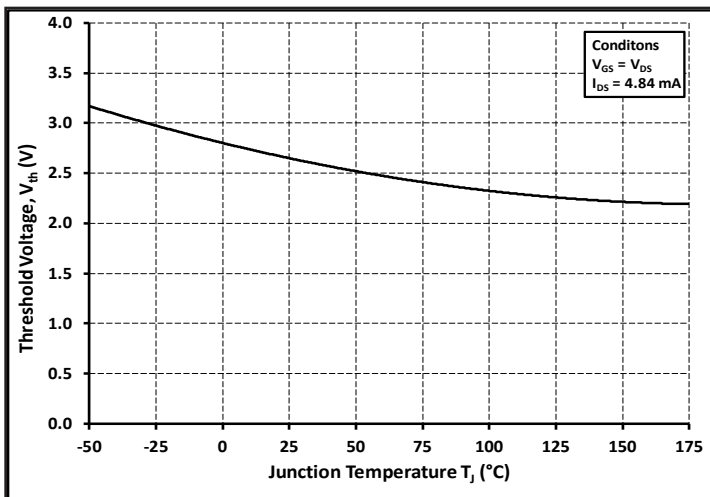

Figure 11. Threshold Voltage vs. Temperature

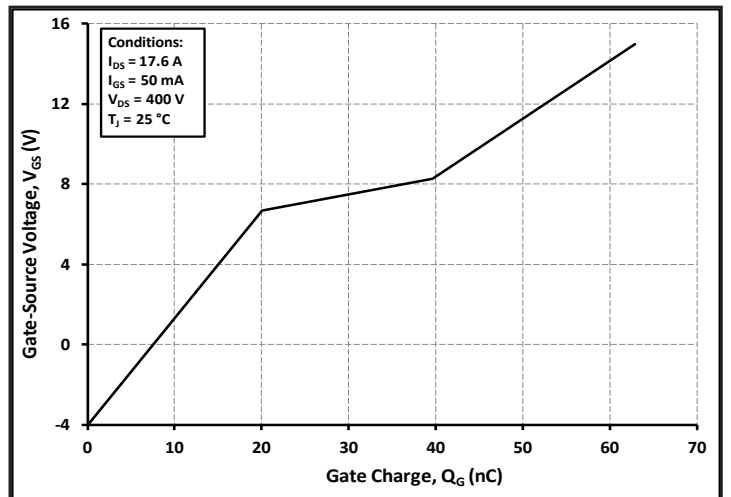

Figure 12. Gate Charge Characteristics

## Typical Performance

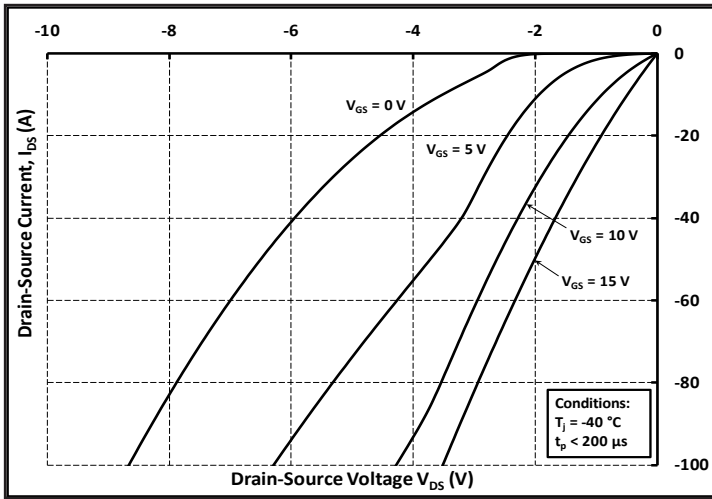

Figure 13. 3rd Quadrant Characteristic at  $-40\text{ }^\circ\text{C}$

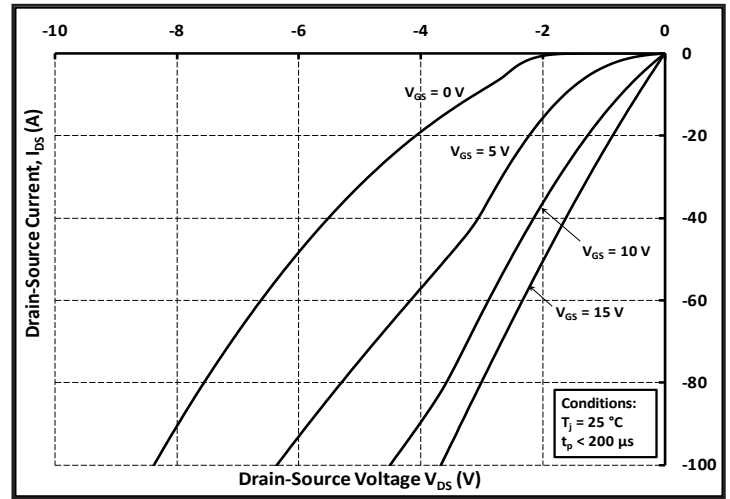

Figure 14. 3rd Quadrant Characteristic at  $25\text{ }^\circ\text{C}$

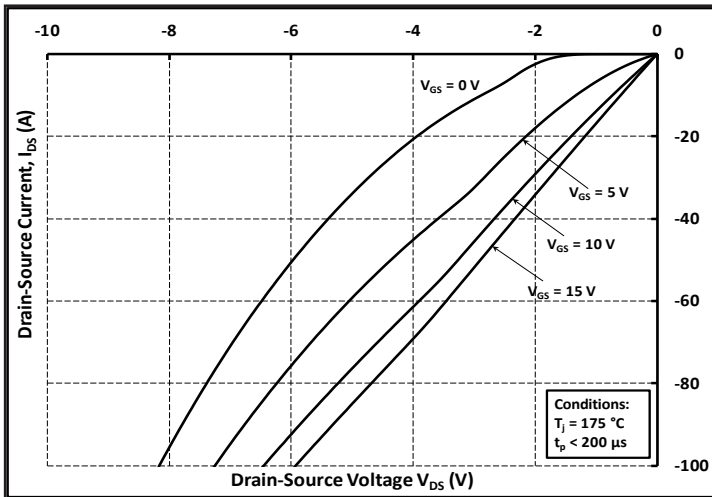

Figure 15. 3rd Quadrant Characteristic at  $175\text{ }^\circ\text{C}$

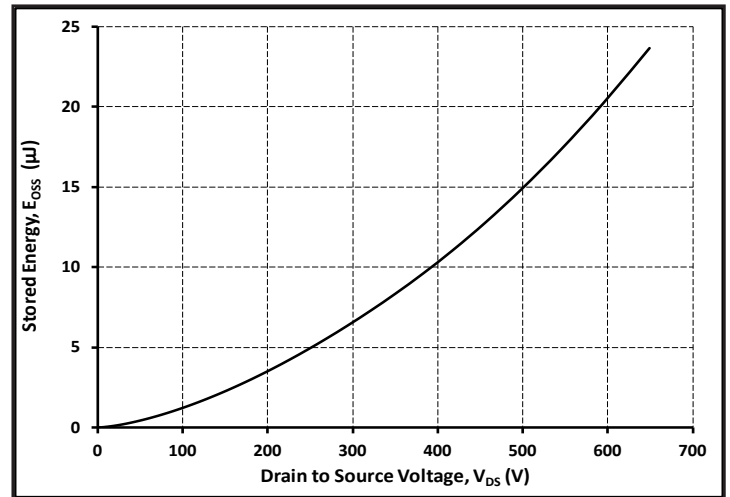

Figure 16. Output Capacitor Stored Energy

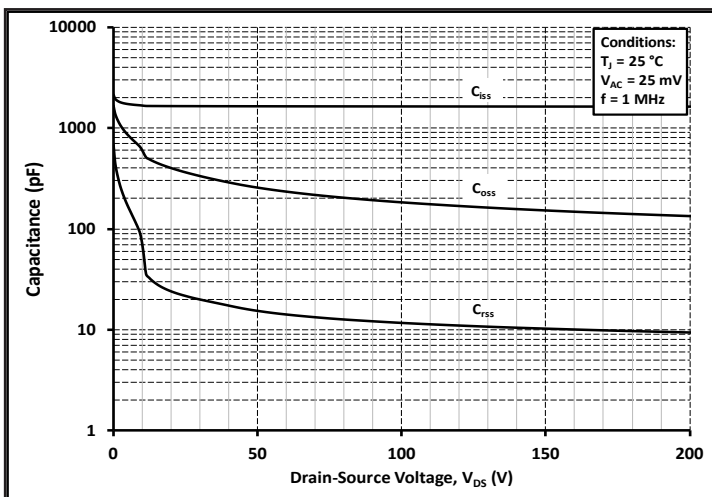

Figure 17. Capacitances vs. Drain-Source Voltage (0 - 200V)

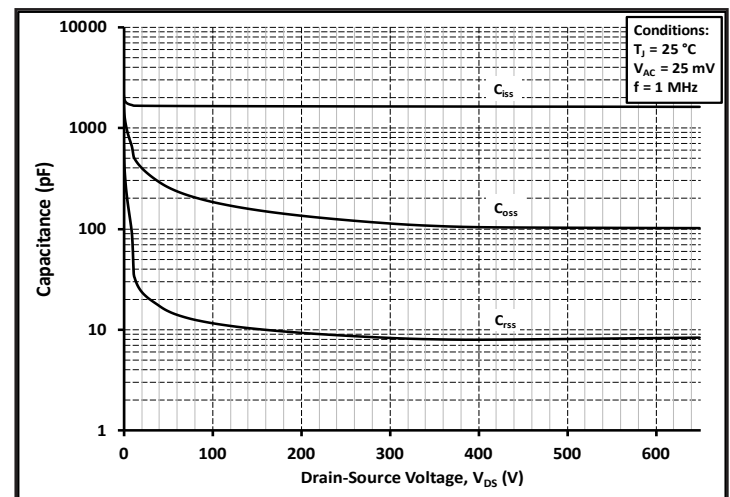

Figure 18. Capacitances vs. Drain-Source Voltage (0 - 650V)

## Typical Performance

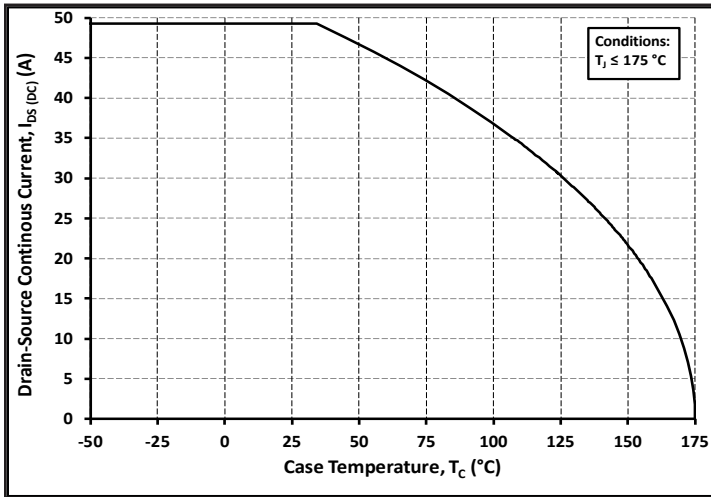

Figure 19. Continuous Drain Current Derating vs. Case Temperature

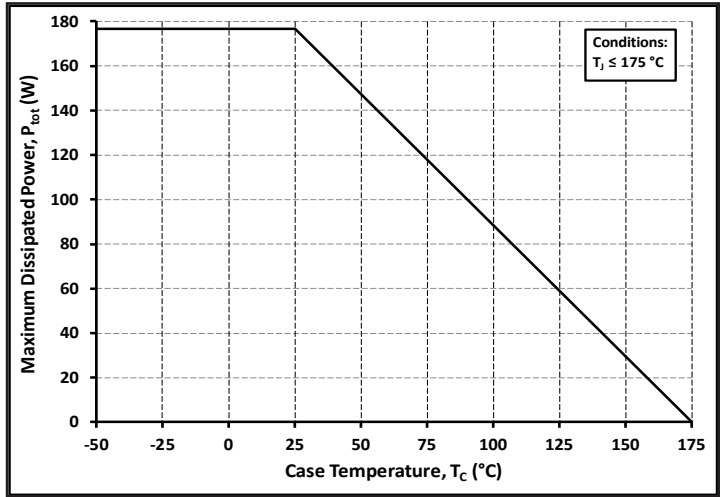

Figure 20. Maximum Power Dissipation Derating vs. Case Temperature

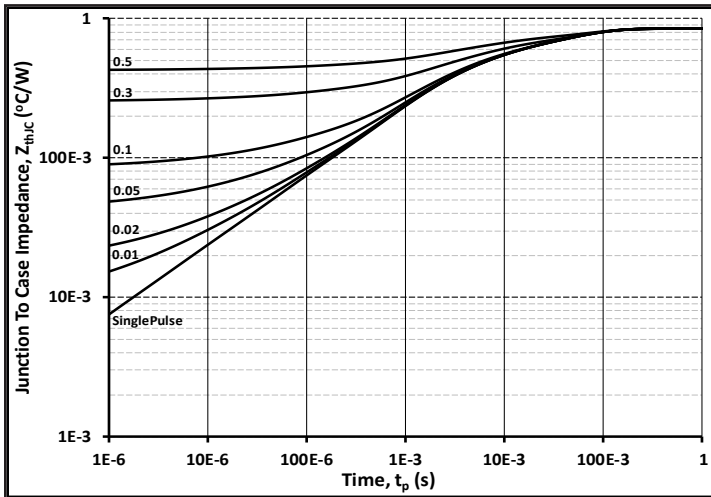

Figure 21. Transient Thermal Impedance (Junction - Case)

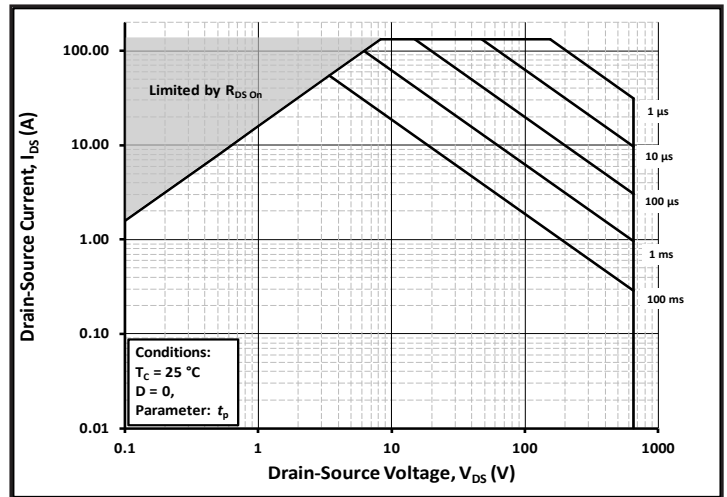

Figure 22. Safe Operating Area

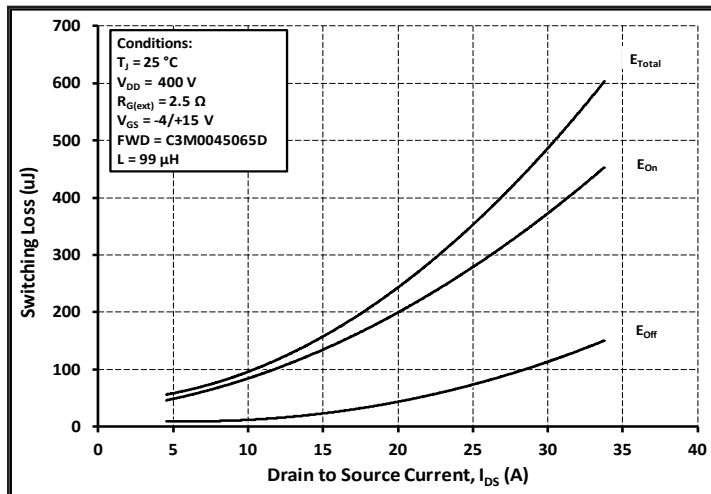

Figure 23. Clamped Inductive Switching Energy vs. Drain Current ( $V_{DD} = 400V$ )

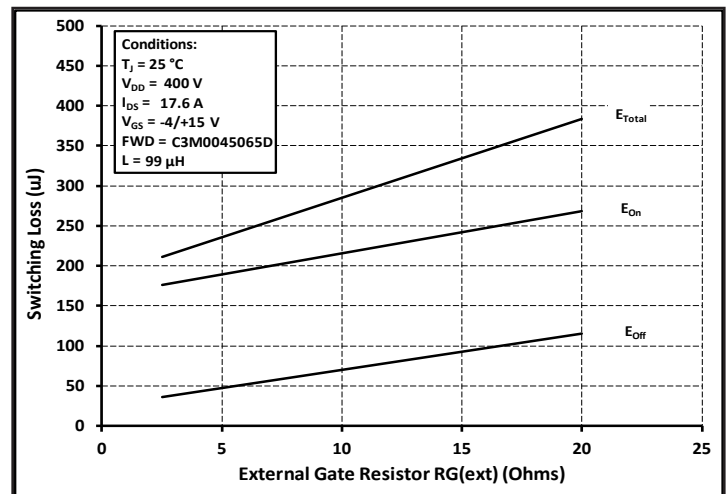

Figure 24. Clamped Inductive Switching Energy vs.  $R_{G(ext)}$

## Typical Performance

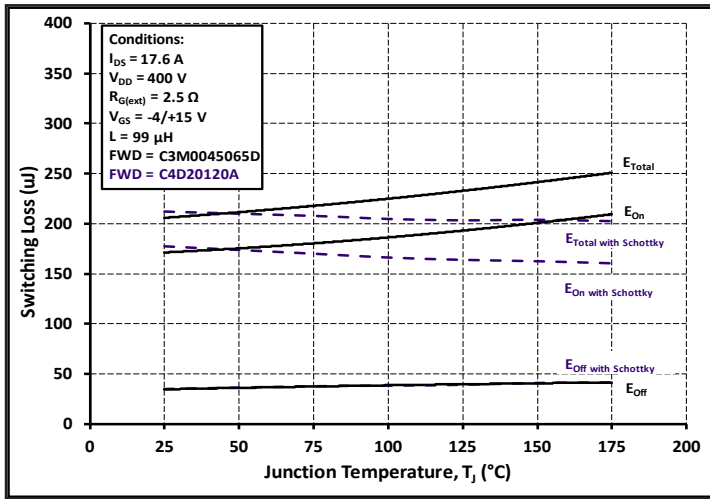

Figure 25. Clamped Inductive Switching Energy vs. Temperature

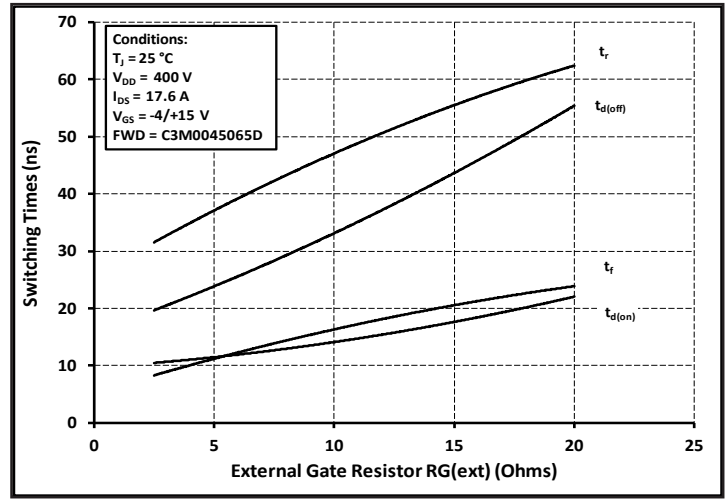

Figure 26. Switching Times vs.  $R_{G(ext)}$



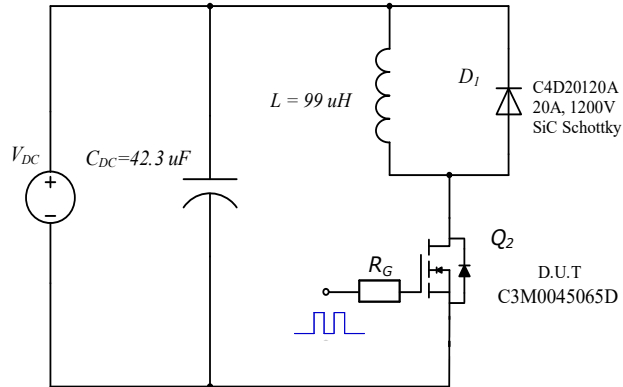

Figure 27. Clamped Inductive Switching Waveform Test Circuit

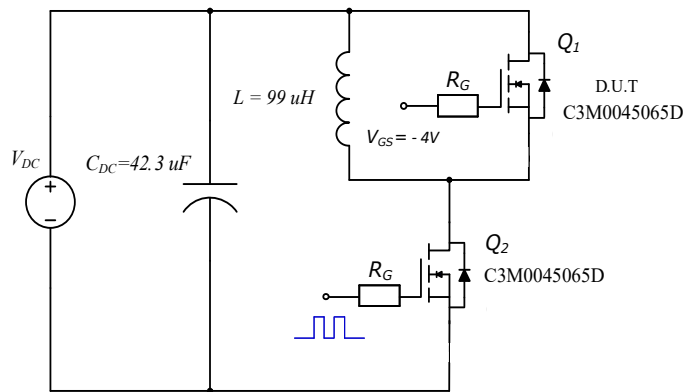

Figure 28. Body Diode Recovery Test Circuit

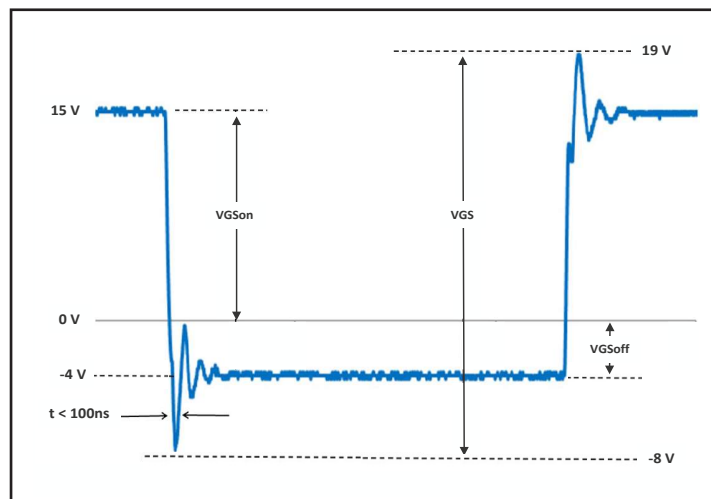
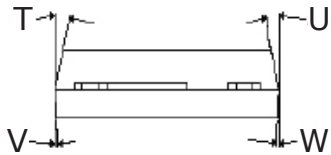
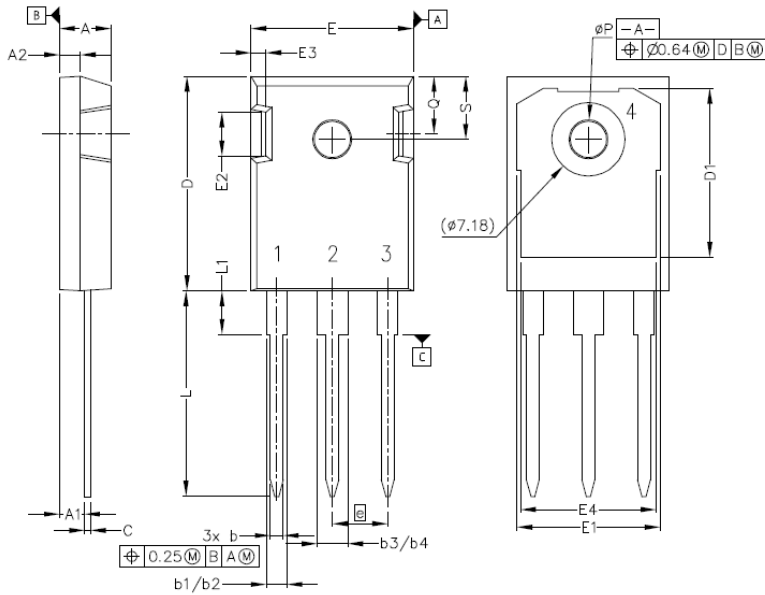

Figure 29.  $V_{GS}$  Waveform Example

## Package Dimensions

Package TO-247-3



Pinout Information:

- Pin 1 = Gate
- Pin 2, 4 = Drain
- Pin 3 = Source

POS	Inches		Millimeters	
	Min	Max	Min	Max
A	.190	.205	4.83	5.21
A1	.090	.100	2.29	2.54
A2	.075	.085	1.91	2.16
b	.042	.052	1.07	1.33
b1	.075	.095	1.91	2.41
b2	.075	.085	1.91	2.16
b3	.113	.133	2.87	3.38
b4	.113	.123	2.87	3.13
c	.022	.027	0.55	0.68
D	.819	.831	20.80	21.10
D1	.640	.695	16.25	17.65
D2	.037	.049	0.95	1.25
E	.620	.635	15.75	16.13
E1	.516	.557	13.10	14.15
E2	.145	.201	3.68	5.10
E3	.039	.075	1.00	1.90
E4	.487	.529	12.38	13.43
e	.214 BSC		5.44 BSC	
N	3		3	
L	.780	.800	19.81	20.32
L1	.161	.173	4.10	4.40
ØP	.138	.144	3.51	3.65
Q	.216	.236	5.49	6.00
S	.238	.248	6.04	6.30
T	9°	11°	9°	11°
U	9°	11°	9°	11°
V	2°	8°	2°	8°
W	2°	8°	2°	8°

## Recommended Solder Pad Layout

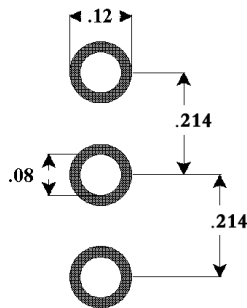

TO-247-3

## Notes

---

- **RoHS Compliance**  
The levels of RoHS restricted materials in this product are below the maximum concentration values (also referred to as the threshold limits) permitted for such substances, or are used in an exempted application, in accordance with EU Directive 2011/65/EC (RoHS2), as implemented January 2, 2013. RoHS Declarations for this product can be obtained from your Cree representative or from the Product Documentation sections of [www.cree.com](http://www.cree.com).
- **REACH Compliance**  
REACH substances of high concern (SVHCs) information is available for this product. Since the European Chemical Agency (ECHA) has published notice of their intent to frequently revise the SVHC listing for the foreseeable future, please contact a Cree representative to insure you get the most up-to-date REACH SVHC Declaration. REACH banned substance information (REACH Article 67) is also available upon request.
- This product has not been designed or tested for use in, and is not intended for use in, applications implanted into the human body nor in applications in which failure of the product could lead to death, personal injury or property damage, including but not limited to equipment used in the operation of nuclear facilities, life-support machines, cardiac defibrillators or similar emergency medical equipment, aircraft navigation or communication or control systems, air traffic control systems.

## Related Links

---

- **SPICE Models:** <http://wolfspeed.com/power/tools-and-support>
- **SiC MOSFET Isolated Gate Driver reference design:** <http://wolfspeed.com/power/tools-and-support>
- **SiC MOSFET Evaluation Board:** <http://wolfspeed.com/power/tools-and-support>